

Owalo 7030 | Instructions

Secto[®]
DESIGN

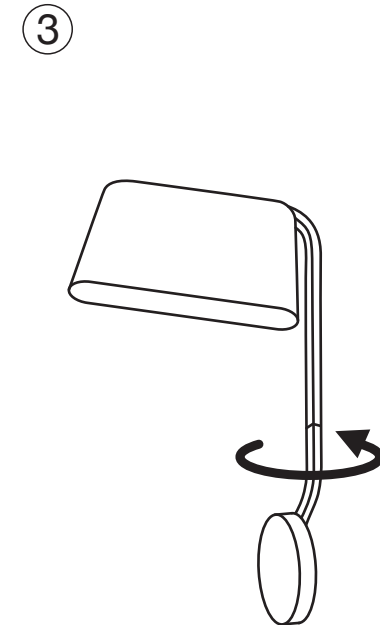
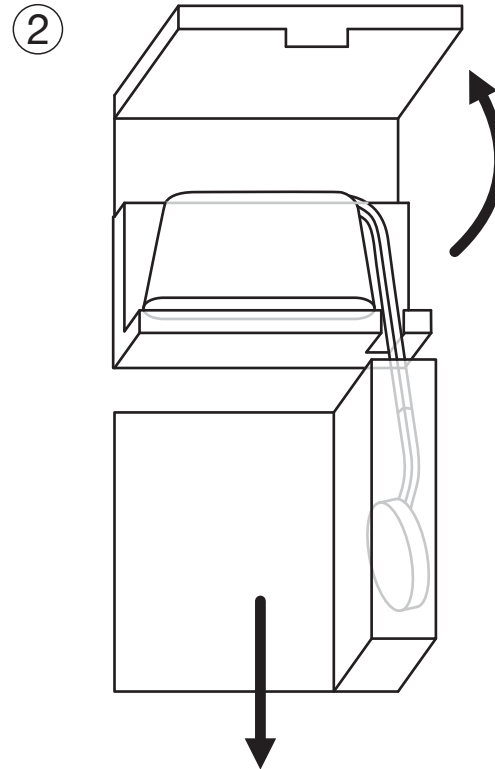
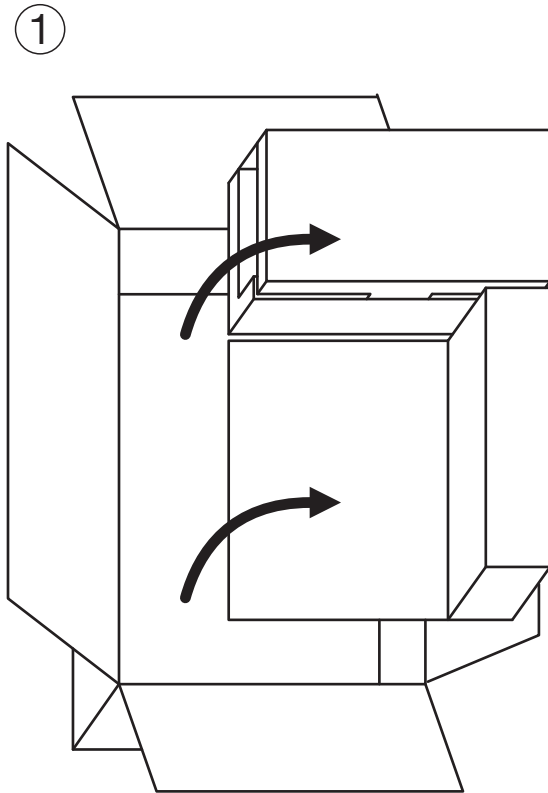

The cable and the built-in LEDs can only be replaced by the manufacturer or a certified electrician.