

Kuulto 9100 | Kuulto Small 9101 | Opening Instructions

Secto
DESIGN

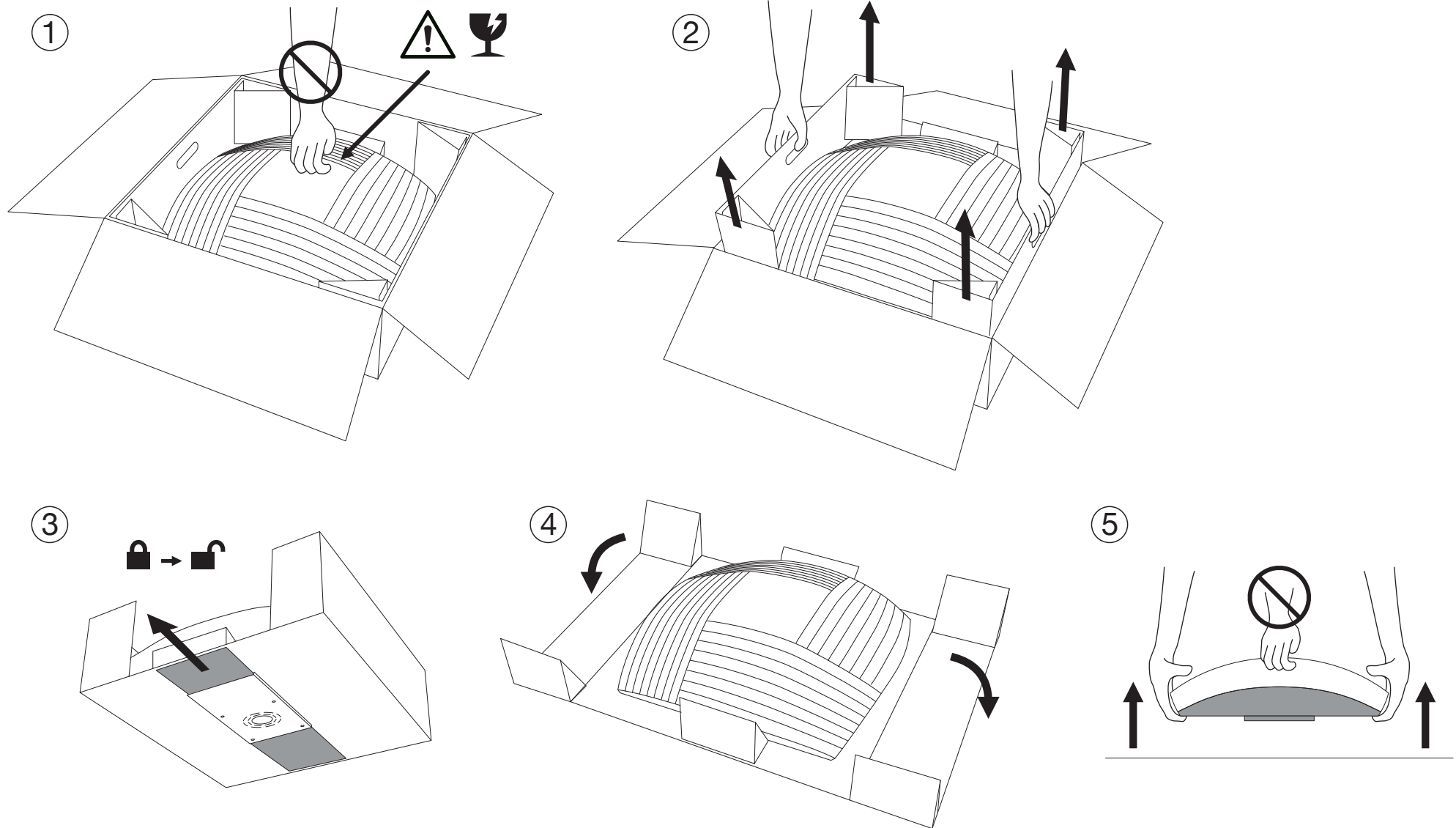

Kuulto 9100 | Kuulto Small 9101 | Instructions



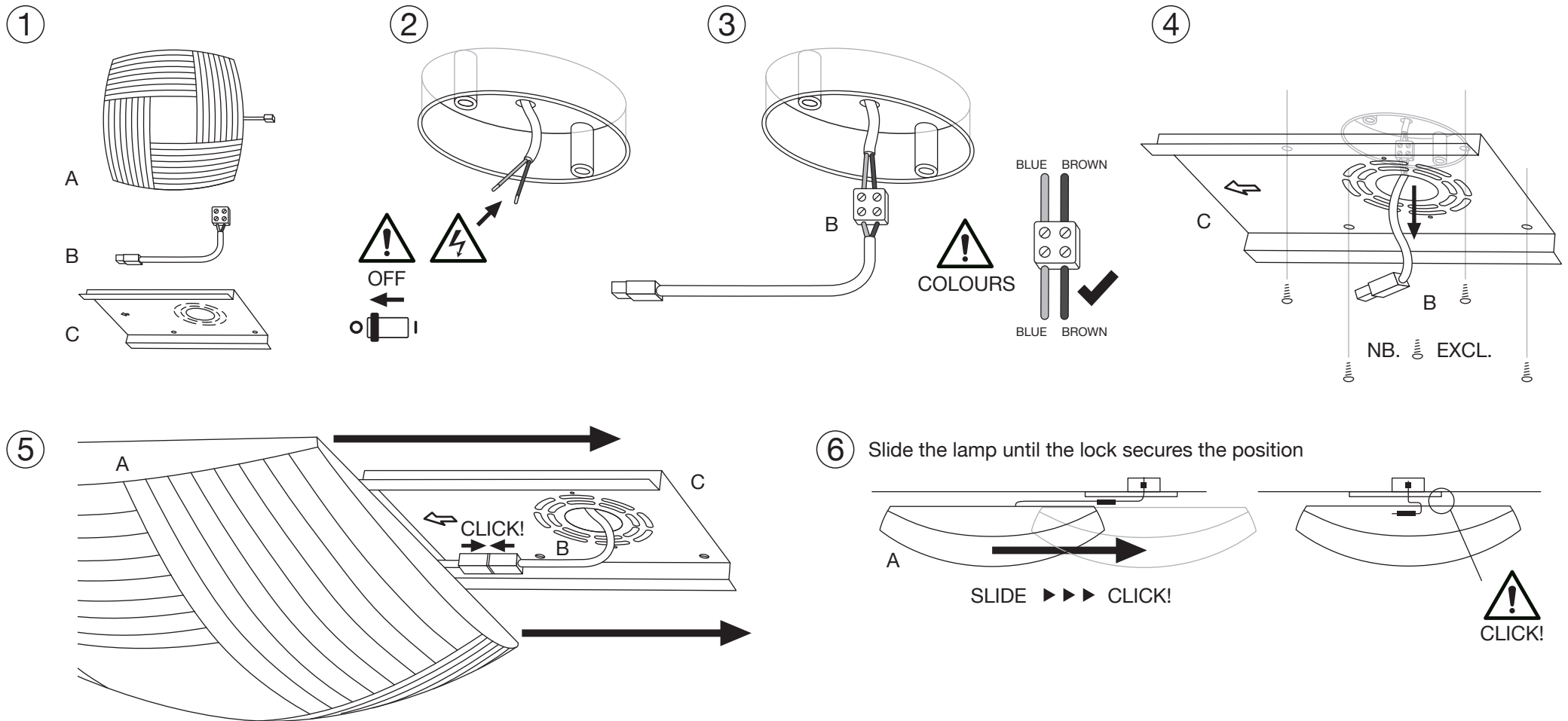





Secto
DESIGN

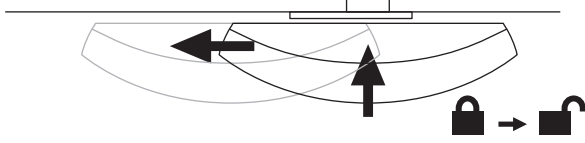
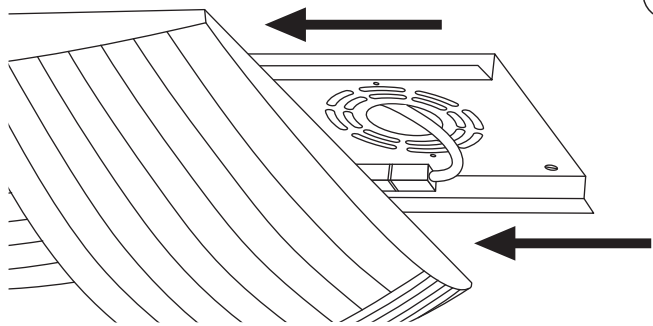
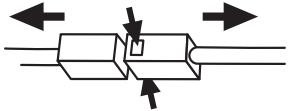
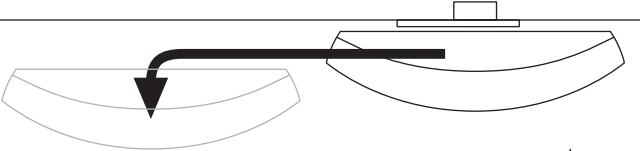

 The cable and the built-in LEDs can only be replaced by the manufacturer.

Kuulto 9100 | Kuulto Small 9101 | Cleaning instructions

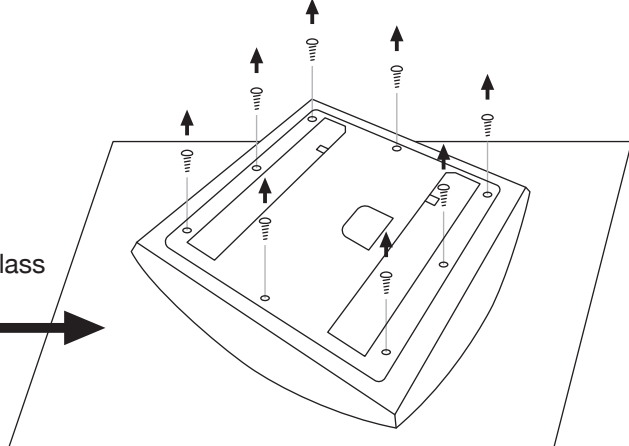
Secto
DESIGN

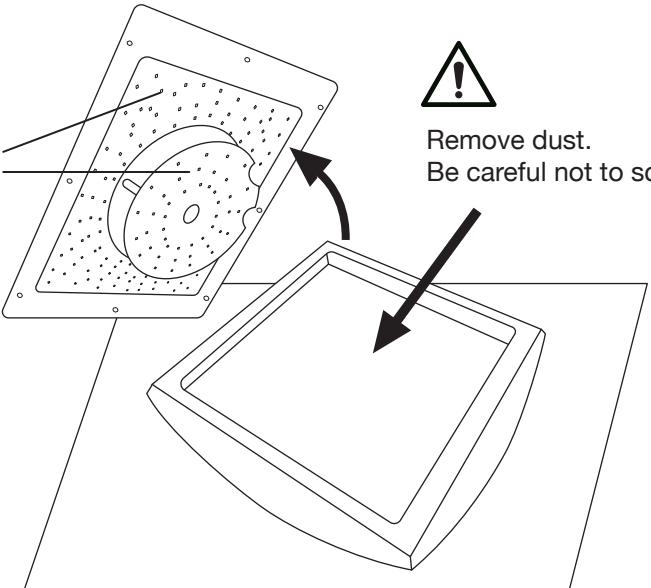
- 
OFF



The lamp should still be supported by the rail until the step 4.
- Lift the lamp and unlock it to slide

- Slide the lamp until the connector becomes accessible

- Disconnect the connector

- Slide the lamp and remove from the rail

- 
Protect the acrylic glass and wooden part with soft material

- 
LED

Remove dust.
Be careful not to scratch.

 The cable and the built-in LEDs can only be replaced by the manufacturer.